

MERRICK & DAY

METAL CURTAIN POLES TECHNICAL DETAILS

32MM METAL POLES

All dimensions in millimetres unless otherwise stated

FINIALS

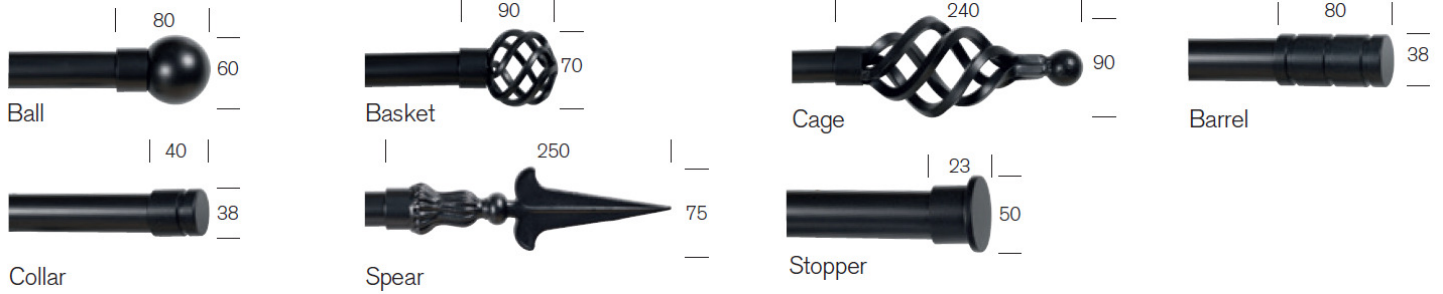

POLE LENGTH

Maximum single pole length / span without central bracket 2.4m/94"

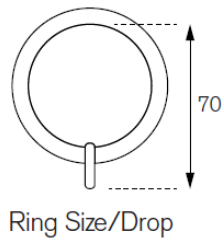
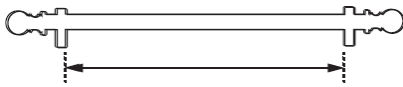

BRACKETS

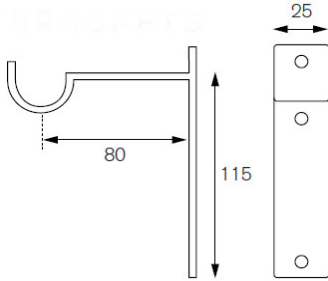

Standard Pole End Bracket

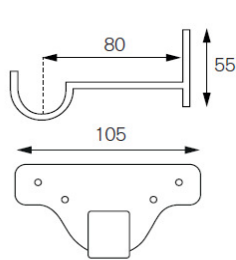

Standard Pole Centre Bracket

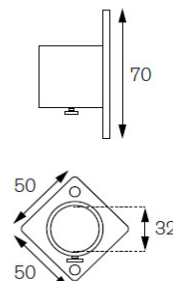

Recess Bracket

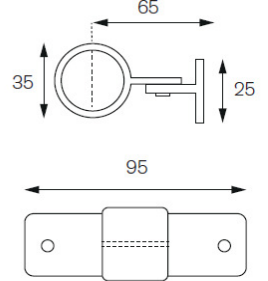

Ceiling Fix Bracket

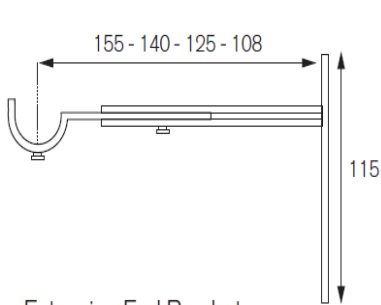

Extension End Bracket

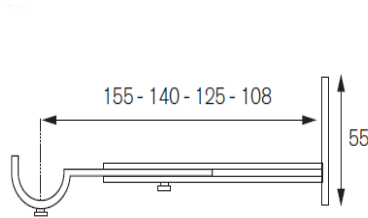

Extension Centre Bracket

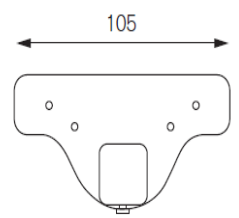

MERRICK & DAY

METAL CURTAIN POLES TECHNICAL DETAILS

ACCESSORIES

All dimensions in millimetres unless otherwise stated

HOLDBACKS

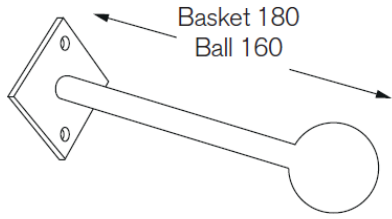

Ball and Basket Post Holdback

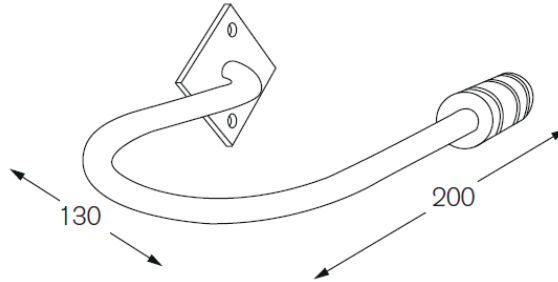

Dimensions for all Metal Holdbacks
(available with every finial except Stoooper and Spear)

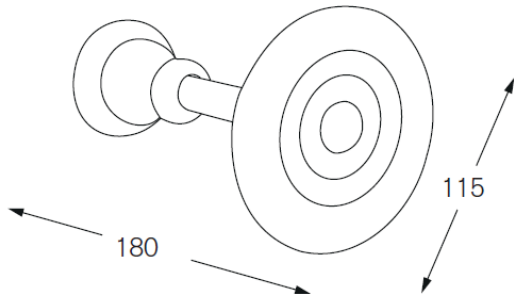

Large Wooden Holdback

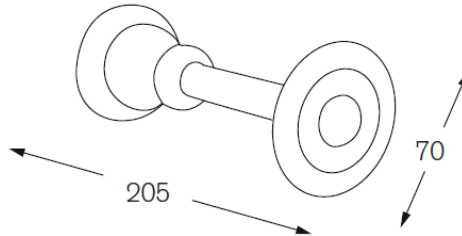

Small Wooden Holdback

PORTIERE RODS

For use over doors and with dormer windows
Hinge plate, pole, finial, rings and 2 x rests

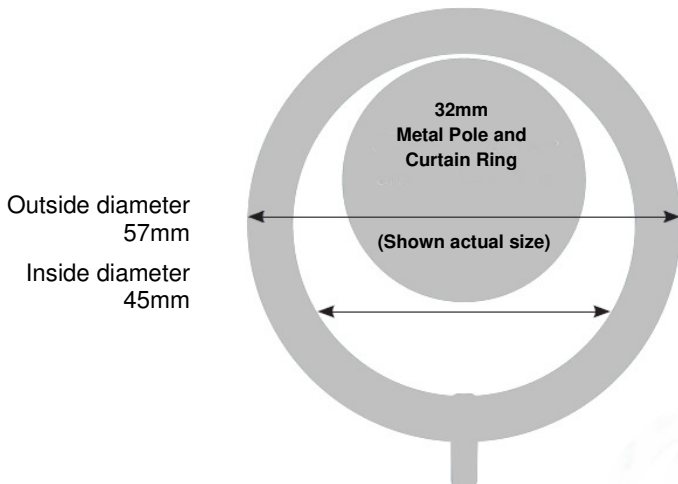
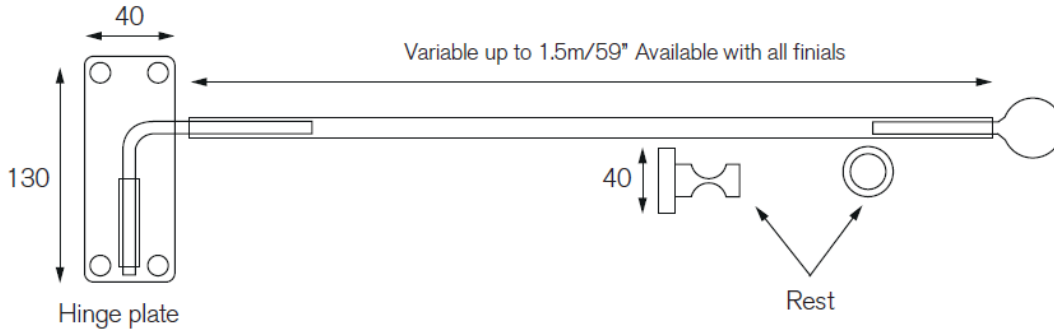

32mm Metal Poles

Maximum span between brackets 2.0m (78")

Maximum Single Pole length 2.4m (94")

DRAW RODS

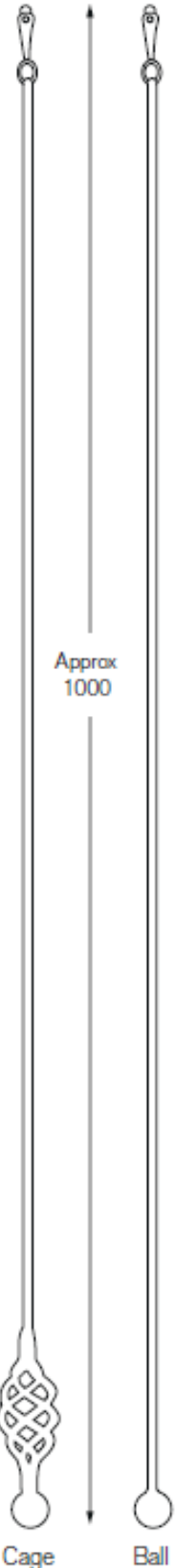

MERRICK & DAY

POLE/TRACK WEIGHT GUIDELINES

Our maximum recommended loadings are total curtain weight based on a combination of pole/track type and span between brackets

METAL

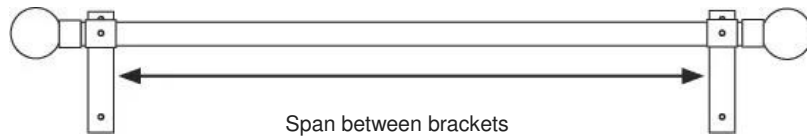

	Upto 1.5 m	Upto 2.0 m	Upto 2.4 m	Upto 3.0 m
19mm poles	5kg	3kg	N/A	N/A
32mm poles	12kg	10kg	5kg	3kg

WOOD

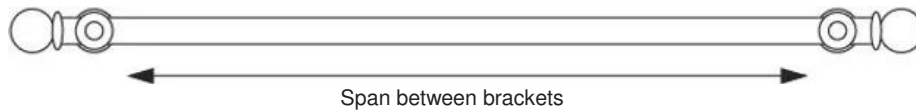

	Upto 1.5 m	Upto 1.8 m	Upto 2.4 m
35mm poles	8kg	6kg	N/A
50mm poles	15kg	12kg	6kg
63mm poles	25kg	20kg	10kg

TRACK

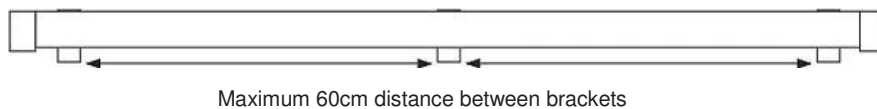

Metal Elegance
Both Straight & Bendable

10kg per metre (Unlimited Length)