

MERRICK & DAY

DELUXE ROTARY CHAIN ROMAN BLIND KITS

The standard kit has a 1:1 chain drive suitable for blinds up to 3kgs in weight. For heavier blinds up to 6Kg use a 1:4 chain drive, see instructions on page 2. There are several ways to make a Roman blind, using some or all of the components in the kit. For example the rod pockets can either be made using the tape included in the kit or by sewing tucks in the lining fabric. The instructions here are for an unlined blind and a lined blind using the rod pocket tape. Adapt these make-up methods to suit your own needs.

To adjust the length of the track

1 Work on the opposite end of the track to the chain drive and take off the end cap. Loosen the screw in the cord reel and slide it along the track to the required end position.

2 Mark the track with a square all the way around where you want to cut it, in order to ensure that the cut will be square. Cut the track to the required size with a junior hacksaw. Loosen the screw in the cord reel next to the chain drive and slide it, with the square drive shaft, 6mm towards the end of the track. Cut off the excess square drive shaft at the end of the track. Brush away any metal dust, slide the square drive shaft and cord reel back to its original position and fit the protective end-cap on the end. The square drive shaft will now be 6mm away from the end cap.

3 If you have more than 2 cord reels re-position the intermediate cord reels to be spaced equidistant from each other and tighten the screws.

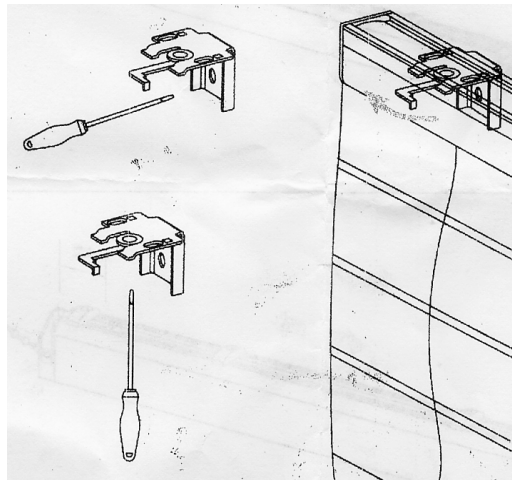

4 Space the wall brackets evenly across the track and mark their fixing positions on the wall. The universal brackets can be face-fixed outside the window reveal or top-fixed inside the window reveal.

5 To release the brackets from the track, pull out the locking lever on the underside of the bracket. Drill, plug and screw the brackets into position and lock the track into place.

ROMAN BLIND SUPER TRACK INSTRUCTIONS FOR 1:4 CHAIN DRIVE

For blinds weighing 4 – 6kg use the 1:4 Heavy Duty chain drive, this is available as a separate accessory. Simply loosen the 1:1 chain drive locking screw, slide it out from the aluminium profile and replace with the 1:4 chain drive. Remove the chain from the 1:1 chain drive by removing the three screws in the end plate and fit the chain into the 1:4 chain drive. Alternatively Brass satin nickel or chrome chain rings may be purchased. Please note: The 1:4 chain drive requires a continuous chain ring, a joiner can not be used.

Roman blind standard pleat calculations

Standard pleating is where the folds lie on top of each other. This calculation

Establish the finished length of the blind.

From the finished length of the blind deduct an allowance for the track of 6cm.

Divide the remaining figure by an **odd** number to find the size of the pleat sections, which should be approximately between 10-20cm (4-8in).

E.g. finished blind length 86cm – 6cm = 80cm to pleat

$80\text{cm} \div 5 \text{ pleat sections} = 16\text{cm folds}$

The rods fall between sections 2 & 3 and 4 & 5 and the folds on the front of the blind fall between 1 & 2 and 3 & 4.

The alternative to 5 pleat sections is either 3 larger sections with 1 rod pocket or 7 smaller sections with 3 rod pockets.

6cm track allowance	
1	16cm pleat section
<i>Fold line</i>	
2	16cm pleat section
<i>Rod pocket tape line</i>	
3	16cm pleat section
<i>Fold line</i>	
4	16cm pleat section
<i>Rod pocket tape line</i>	
5	16cm pleat section

©Merrick & Day
www.merrick-day.com

To make an un-lined Roman blind

1 Establish the finished size of the blind.

2 Cut the fabric the finished measurements of the blind adding 8cm to each side, to the top and to the bottom for turning allowances. If using a patterned fabric centralise a motif in the middle of the blind also placing a suitable pattern at the top and base of the blind.

3 On the right side of the fabric mark with pins the 8cm side and 8cm bottom turning allowances. Place a pin in each corner points.

4 Lay the fabric onto the table with the wrong side uppermost. Turn in the sides and hem 4cm and then a further 4cm and pin in place.

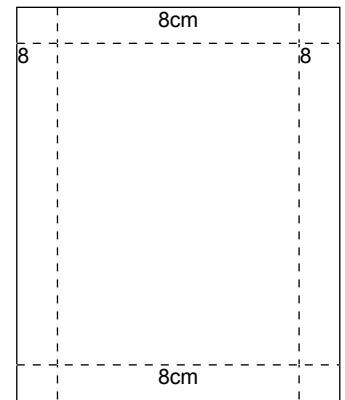

Turn each corner up 45 degrees so that the fold runs through the corner pin. Turn up the first 4cm and then the second 4cm to make the mitred corners and pin in place. Trim away the excess fabric in the corner of the mitre.

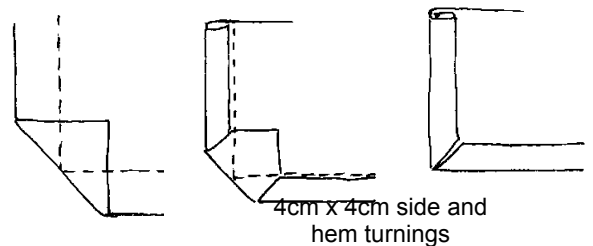

5 Machine or hand-sew along the sides and lower edge turnings. Leave the mitres open to insert the flat aluminium bar later.

6 Calculate the rod pocket tape positions (see page 1). Mark the horizontal lines of the tape positions on the wrong side of the blind with either a row of pins or a chalk pencil.

7 Cut the tapes the width of the blind, in the same place to ensure they line up vertically. Place the tapes onto the marked lines with the open slits for the fibreglass rods facing the top of the blind. Turn the ends of the tape in 2cm to close and neaten, and machine in place on the lower edge of the tape. Hand-sew the ends of the tape to neaten.

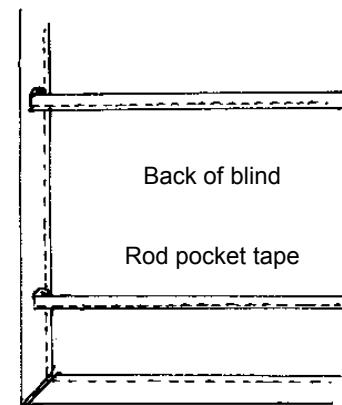

8 Working on the right side of the blind measure the finished length up from the hem and mark with a row of pins. Fold the fabric over along the pin line. Machine the loop tape onto the back of the blind along the top edge only. Trim away the excess fabric to within the depth loop tape. Machine the lower edge and the ends of the tape.

9 Cut the required number of fibreglass rods to the length of the sewn rod pocket tape less 1cm. Wear protective gloves as fibreglass splinters, wrap tape around the cutting area and then cut with a hack-saw. Fit the protective plastic end caps. Slip the rods into the rod pocket tape through the slits at the top of the tape.

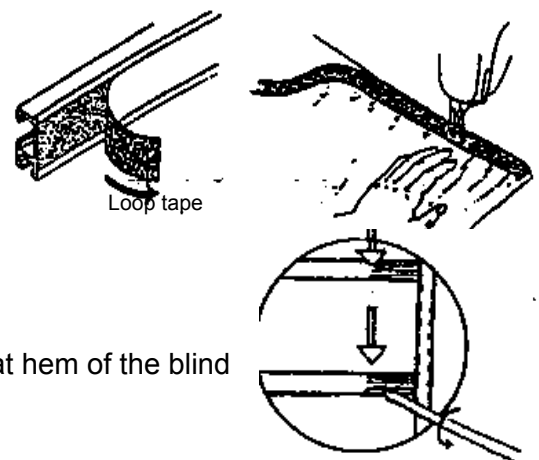

10 Cut the flat aluminium bar to the width of the blind less 2cm in the same way as the fibreglass rods. Fit the plastic end caps at each end of the bar to prevent snagging the blind fabric. Slip the bar through the mitres at hem of the blind and hand-stitch to enclose.

To make a lined Roman blind

1 Establish the finished size of the blind.

2 Cut the fabric the finished measurements of the blind adding 5cm to each side, to the top and to the bottom for turning allowances. If using a patterned fabric centralize a motif in the middle of the blind also placing a suitable pattern at the top and base of the blind.

3 On the right side of the fabric mark with pins the 5cm side and 5cm bottom turning allowances. Place a pin in each corner point.

4 Lay the fabric onto the table with the wrong side uppermost. Turn in the sides and hem 5cm and pin in place.

Turn each corner up 45 degrees so that the fold runs through the corner pin. Turn up 5cm to make the mitred corners and pin in place. Trim away the excess fabric in the corner of the mitre.

5 Cut out the lining to the finished width of the blind and add 5cm to the length of the blind. Fold and press in 2.5cm down the sides and 2.5cm along the lower edge of the lining. Temporarily pin the lining into position on the back of the blind 2.5cm in from each side and 2.5cm up from the hem fold.

6 Calculate the rod pocket tape positions (see page 1). Mark the horizontal lines of the tape positions on the lining with either a row of pins or a chalk pencil. Remove the lining from the blind fabric.

7 Cut the tapes the width of the blind, in the same place to ensure they line up vertically. Place the tapes onto the marked lines with the open slits for the fibreglass rods facing the top of the blind. Turn the ends of the tape in 2cm to close and neaten, and machine in place on the lower edge of the tape. Hand-sew the ends of the tape to neaten.

8 Re-position the lining onto the back of the blind 2.5cm in from the sides and up 2.5cm up from the hem fold. Slip stitch down each side and along the hem taking care not to stitch through to the front of the blind.

To hold the fabric and lining together sew small 'spot tack' stitches through the fabrics just below the rod pocket tape wherever the cords will be positioned. These will be barely visible from the right side of the blind and less obtrusive than rows of machine stitching.

Continue steps 8-10 as for an unlined blind.

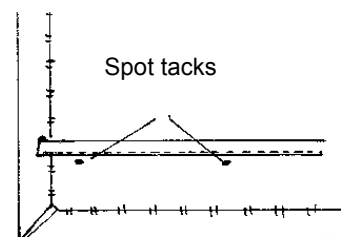
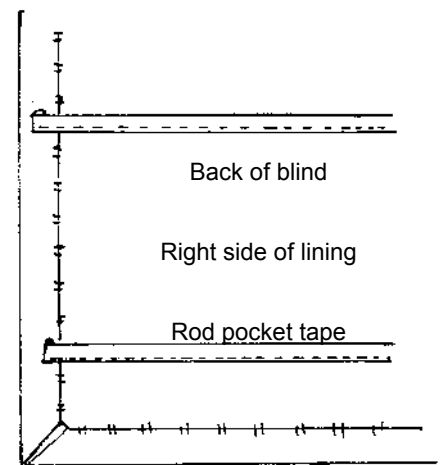
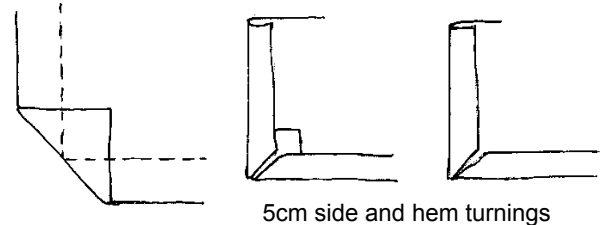
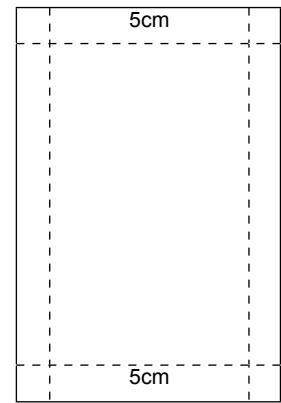

To fit the blind to the track

1 Adjust the length of the track and fit the brackets to the wall or ceiling as described on page 1.

2 Now fit the blind to the track before fitting onto the brackets. Press the loop tape on the blind to the hook tape on the track.

3 Attach the small plastic 's' hooks to the clear plastic rings and then to the small slits in the rod-pocket tape in line with the tape reels omitting the lowest rod pocket tape.

4 Fully extend the tapes out of the reels and thread the through the rings.

5 Fit the locking devices onto the lowest rod pocket tape. With the hook uppermost, facing the tape, pull the hook down through the small slit in the tape and turn the locking device to the top of the tape. Trap the tapes through the locking devices. Trim the ends of the tape to within 10cm to allow for adjustment.

6 Lock the blind head rail onto the brackets. It may be necessary to adjust the tensions of individual tape using the locking device at the bottom of the blind.

7 To adjust the length of the chain ring, with the blind in the down position, cut the outside chain 10cm below the chain drive. Cut away the surplus chain and re-join using the chain connector.

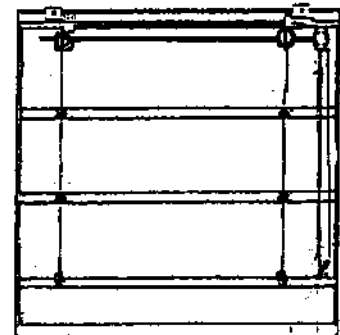
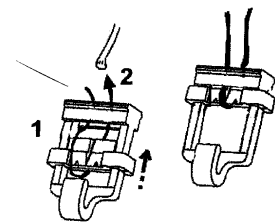
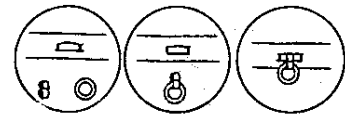
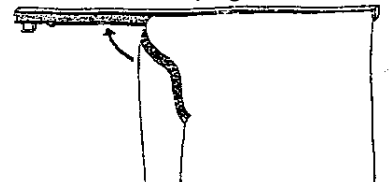

© Merrick & Day. We have made every effort to ensure that all the instructions and measurements are accurate and safe, but we cannot accept any liability for any resulting injury, damage or loss to either person or property whether direct or consequential and howsoever arising.